

VK PS SERIES

Dryer Booster Fans



Designed to solve dryer vent problems where more airflow is needed.

The VENTS VK PS dryer booster fans assure efficient and reliable operation. The pre-installed pressure switch allows the VK PS fan to run when it senses the dryer on. The controller cycles the fan until the dryer has stopped. The fans are fitted with backward curved centrifugal impeller, which prevents lint from getting stuck in the fan. The fans are driven by powerful sealed external rotor motor with lifelong bearings and thermal protection. This powerful combination enables the VK PS to deliver exceptional airflow performance even in long duct runs. The fans' casing is made of high quality, UV-resistant plastic (UL94 certified plastic). The fans are specially designed for simple installation and years of maintenance free operation.

FEATURES

- Pressure switch for fan activation and mounting bracket included as shown in above picture.
- Sizes available from 4" - 6".
- High static pressure applications.
- Backward curved centrifugal impeller.
- Quiet external rotor motor with thermal overload protection.
- Ideal for long duct runs.
- Quiet and powerful.
- Vibration free operation.
- Energy efficient.
- Maintenance free.
- Easy installation.
- Corrosion resistant.
- UV resistant, UL94 certified plastic.
- Pre-wired and supplied with mounting bracket for easy installation.
- 3 year warranty.



PERFORMANCE SPECIFICATIONS

MODEL	RPM*	SONES	DUCT DIA.	WATTS*	CFM VS. STATIC PRESSURE (Ps) IN WG											VOLTS / Hz
					0"	0.125"	0.2"	0.25"	0.375"	0.5"	0.75"	1.0"	1.25"	1.5"		
VK100 PS	3088	8.5	4"	106	162	155	150	147	141	134	120	104	87	67	120 / 60	
VK125 PS	2960	7.1	5"	114	235	222	214	207	193	178	151	123	99	72	120 / 60	
VK150 PS	2907	7.2	6"	113	317	300	289	282	265	247	212	178	132	68	120 / 60	

* The parameters RPM, Watts are indicated at 0.2 in WG static pressure.

DIMENSIONS

MODEL	DIMENSIONS (Inches)								WEIGHT (lbs)
	ØD	ØD1	B	B1	L	L1	L2	L3	
VK100 PS	3 15/16"	9 13/16"	10 5/8"	13 3/8"	9 1/16"	1 3/16"	1 1/16"	1 3/16"	4.7
VK125 PS	4 15/16"	9 13/16"	10 5/8"	13 3/8"	8 11/16"	1 3/16"	1 1/16"	1 3/16"	4.9
VK150 PS	5 7/8"	11 13/16"	12 3/16"	13 3/8"	11 1/4"	1 3/16"	1 3/16"	1 3/16"	5.7

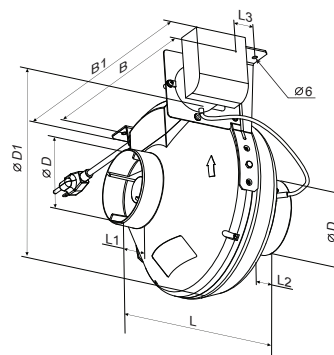

ACCESSORIES

- Lint Trap (LT-250-45)

For more information on available accessories, see pages J8-J11 in Accessories & Motors section.