

ULTRALITE CONTROLLER

KEY FEATURES



- Easily mounted to wall.
- Control each fan individually.
- Operate your fans for cooling and destratification.
- Manually control each fan's forward speed.

TECHNICAL SPECIFICATIONS

Power Supply	0-10V DC analog from VFD
Dimensions	3.125" W x 3.125" H x 2.5" D
Weight	0.5 lb.
Language Protocol	0-10v signal
User Interface	Rotary dial
Enclosure	ASA Plastic
Fans/Control	Single fan control
Power Consumption	0.5W power consumption
Connections	5-core shielded wire, field supplied.
Max Cable Length	100 Ft.
Rating	IP44 (inset), IP54 (surface)

ULTRALITE PACKAGE CONTENTS & ASSEMBLY

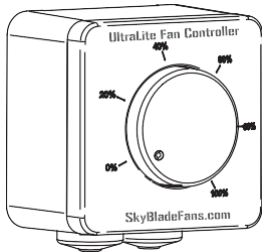

A. UltraLite Controller
(x1)

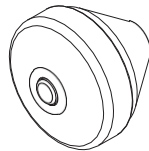

B. Plastic Bushing
(x2)

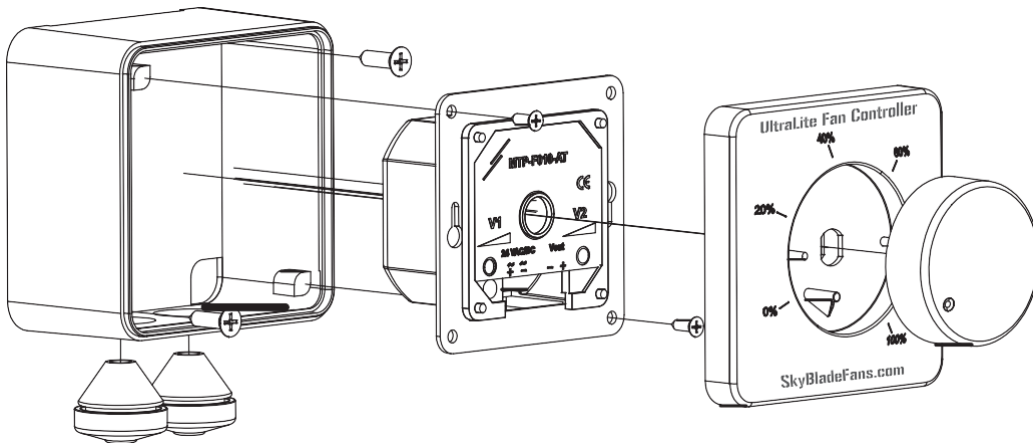

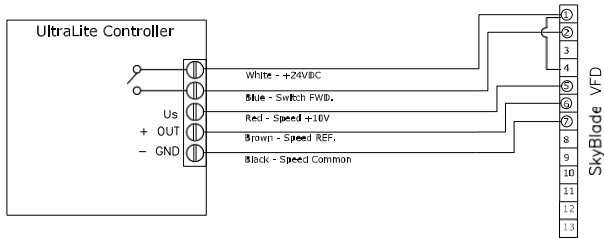
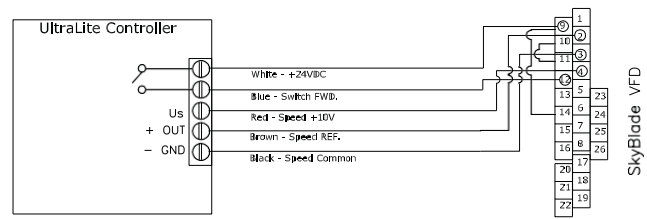
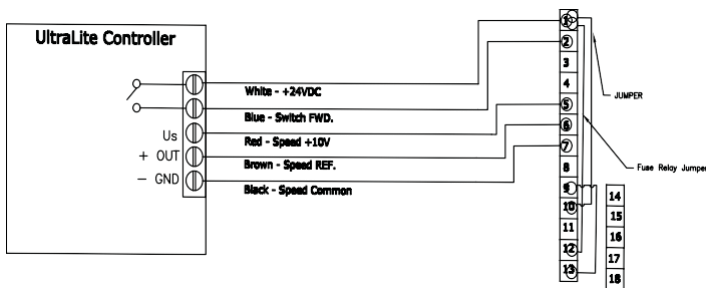
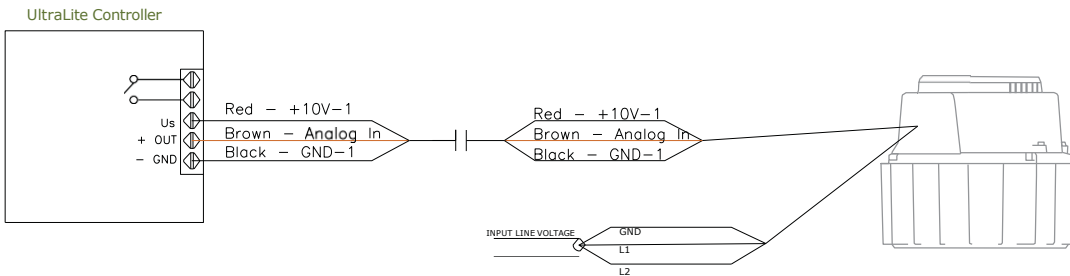
WIRING DIAGRAM - GEARED DRIVE FAN
120V/1PH

230V/3PH, & 460V/3PH

575V/3PH

WIRING DIAGRAM - DIRECT DRIVE FAN
120V/1 PH & 230V/1PH

230V/3 PH & 460V/3 PH
