

Faromor NV4 4 Zone Natural Ventilation Control Operators Manual



Controller Features:

- › Controls 4 Curtain Actuators (10 Amp, 115/230V, 1/2HP)
- › Controls 2 On/Off Fans or Heaters (10 Amp, 115/230V) with Cycle Timer Option
- › Supports 4 Temperature Probes
- › Select Probes to use for Curtains and On/Off Stages
- › Curtain Timers Accurate to 1 Second
- › Different Temperatures can be set for Each Zone
- › Curtain Run Timers and On/Off Run Timers record how long each device operates.
- › Automatic Curtain Timer Adjustment for Sudden Temperature Changes
- › Manual Curtain Movement with Latching
- › High and Low Temperature Records for average room temperature and each probe.
- › 4 Digit Display
- › User Friendly Setting Adjustments
- › Indicators for Curtain and On/Off Stage Activity
- › High and Low Alarm Settings Option
- › Alarm Relay to Trigger Auto Dialer or Alarm System
- › Wind Sensor Option to Automatically Close Curtain when Windy
- › Rain Sensor Option to Automatically Close Curtains when Rain is Detected.
- › Limit Curtain Openings in Winter without having to Adjust Actuator Limit Switches

Table of Contents.

Controller Features	1
Display Mode	4
Standard Settings	7
Hidden Settings	10
Standard Settings Chart	17
Hidden Settings Chart	18
Mounting Instructions	19
Wiring Diagrams	20
Warranty	24

Controller Features

4 Digit Temperature Display.

Units indicators show the units of measure of the value on the display.

Graphic indicators for changing parameters and device operation.

FAROMOR
YOUR NATURAL CHOICE

4 Zone Natural Ventilation Control

Min Max °F °C
Hrs Mins Secs Probe

Adjust

High Temp. Alarm

Set Point

Low Temp. Alarm

Timer (on/off)

Purge

Dead Band

Heat Offset

Heat 1 Cool 1

Heat 2 Cool 2

open

close

Curtain 1 2 3 4

Wind Sensor 1 2 3 4

Rain Sensor 1 2

Mode

Select

Display Mode: use [left] [right]
default = Average Room Temp.
d11 - d14 = Each Probe Temp.
[up] = High [down] = Low, [up]+[down] = Reset
d20 = High / Low Time Since Reset
d30 - d34 = Manual Move Actuator
d40 - d46 = Run Time [up] = Secs.
[down] = Curtain % Open, [up]+[down] = Reset
d50 = Purge Time Count in Hours

Standard Params: press [right] then [left] [right]
P101 = Room Set Point
P111 = Curtain Offset (usually hidden)
P112 = Curtain Dead Band
P113 = Curtain Open On Time (secs)
P114 = Curtain Close On Time (secs)
P115 = Curtain Off Time (secs)

Hidden Params: see manual
or www.faromor.com

DANGER - MORE THAN ONE POWER SUPPLY. DISCONNECT ALL SUPPLIES BEFORE SERVICING TO AVOID ELECTRIC SHOCK.

5 Buttons used to easily modify and save parameters. Use the buttons to scroll through display information.



List of display mode parameters and standard setting parameters.

Control Operation



Under normal operating conditions, the control will show the average room temperature on the red LED display. Any Alarm codes will flash on the display.



The  button can be used to change from display mode to settings mode or even hidden settings mode.

The  and  buttons will scroll through the various display mode values. The  and  buttons will display additional information.

Factory Settings

At times, it may be necessary to completely reset a control to the factory settings. This is accomplished by holding down the 3 buttons ,  and  as the power is turned on to the control.

The buttons must be held down until the display shows  which indicates that the EEPROM settings have been loaded with the factory default values.

Alarms

When the control encounters an alarm condition, an alarm code will flash on the LED display. The Alarm Output indicator will also flash. If an external alarm is connected, it will be activated (for any alarms other than Power Failure Reset). When the alarm condition has been cleared, the  button will reset the alarm.

The LED Display will normally show the average room temperature. In the event of an alarm condition, the LED display will flash alarm codes 4 times. The following codes may appear.

<i>LED Display</i>	<i>Alarm Description</i>
H 1 1	High temperature Probe 1
H 1 2	High temperature Probe 2
H 1 3	High temperature Probe 3
H 1 4	High temperature Probe 4
L 0 1	Low temperature Probe 1
L 0 2	Low temperature Probe 2
L 0 3	Low temperature Probe 3
L 0 4	Low temperature Probe 4
noPb	No valid probes are connected. The curtains will not normally move.
PF	Power Failure Reset. This appears after the controller has reset – usually due to a power failure.

When alarms have occurred, be sure you **do not press** the  button since this will clear all alarms. Once all the alarm codes have been noted, the mode button may be pressed to clear the alarms. The alarm condition must have been corrected in order to clear the alarm code.

Display Mode:

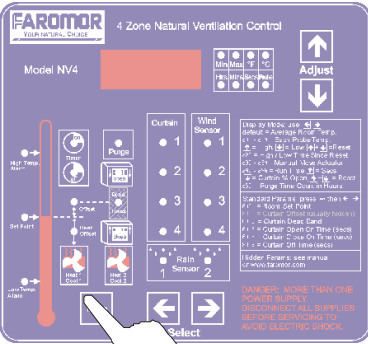

To return to the default display mode:

Press the **Mode** Button. If the display flashes **P 10 I** then press the mode button again. The display will then show the average temperature of the connected sensors.

The **▲** arrow will show the high average temperature reading since the last reset and the **▼** arrow will show the low average temperature reading since the last reset.

NOTE: The control will automatically return to the default display mode 2 minutes after the last button press.

From the default display mode, use the select arrows **◀** and **▶** to display various values. These values are described in the following sections.

d 11 Probe 1 Temperature

This display Parameter shows the temperature at probe 1. Use the **▲** arrow to show the highest reading on this probe since the last reset. The **▼** arrow will show the lowest temperature. Press both arrows to reset the high/low readings for all the probes and the room average.

d 12, d 13, d 14 Probe 2, 3 and 4 Temperature



This display Parameter shows the temperature at probes 2, 3 and 4. Use the **▲** arrow to show the highest reading on this probe since the last reset. The **▼** arrow will show the lowest temperature. Press both arrows to reset the high/low readings for all the probes and the room average.

d 20 Time Since Last High/Low Reset

This display Parameter shows the time since the last high/low temperature reset. Usually, this value will be displayed in hours and minutes HH.MM. Use the **▲** arrow to show the seconds. If the reset is not used for a long time, it is quite possible for the time since reset to be measured in days. When this happens, the value displayed will be in days (with 2 decimal places) and the display will flash **dAYS** to indicate that the measurement is in days instead of hours and minutes. Use both **▲** and **▼** to reset the high and low readings and reset this timer to 0. Be sure to record the high and low values before performing the reset.

30 Manually Move All Actuators

Up to
Close

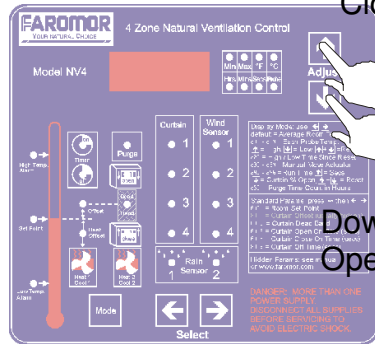

Press the  Arrow
To move all curtains
Closed. Press the 
Arrow to move
all curtains Open.
If the direction button is
held for 8 seconds or more
the curtain movement will
'latch' and the curtain will move
to either the fully open
or the fully closed position.

To indicate this, the
display will change from
horizontal lines
to horizontal lines
with sides
when latched.





Down to
Open

Display shows this pattern
when curtains are latched
stopped 



To latch a curtain in position, briefly press both the  Arrow and the  Arrow
at the same time. Curtains will stay latched until the  Mode button is pressed (or the
opposite direction is chosen). Note that latched curtain actuators will NOT
operate automatically and they will not respond to wind or rain sensors. To
return to display room temperature while latched, the Select Arrows must be
used to return to the default display Parameter. When a curtain is latched, the
Curtain Indicators will flash. Curtains will remain latched even after a power
failure.

31 32 33 34

Manually Move Individual Actuators

Press the  Arrow to close the actuator for the zone. Press the  Arrow to
open the actuator for the Zone. Individual actuators will latch if the direction
arrow is held for more than 8 seconds (See Above)

40 Run Time Since Reset

This display Parameter indicates how long it's been since the last Run Time
reset. This value is displayed as HH.MM. Press the  arrow to display the
seconds portion of the run time. (The curtain and stage run-times are
completely separate from the high/low temperature readings.) Pressing both 
and  will reset the run time readings for all curtains and on/off stages. Be
sure to record all the run times before activating the stage run-time reset. These
button functions are the same for Display Parameters 41, 42, 43, 44, 45 and 46.
The maximum allowable value is 99.59 (or about 4 days). It is important to
record and reset the run-time values daily.

ⓓ41 ⓓ42 On/Off Stage 1, 2 Run Times

These Parameters show how long the On/Off outputs have been on for. This is helpful to determine how much heaters have run and if changes must be made to conserve energy.

ⓓ43 Curtain 1 Run Time

This display Parameter indicates how long Curtain 1 has run since the last reset. Using Parameters 245, 246, 247 and 248 (Time to Run Curtain Fully Open from Closed) this control estimates when the curtain has reached the open or closed limit and does not count run time for a curtain when it is fully closed or open. This parameter can be useful to detect if curtain settings are too tight and the curtain moves too much. Press the  arrow to show curtain % open (based on the time readings).

ⓓ44 ⓓ45 ⓓ46 Curtain 2, 3 and 4 Run Time

These display Parameters are very similar to ⓓ41 above but show the information for curtains 2, 3 and 4.

ⓓ50 Purge Timer

This Display Parameter indicates how soon a purge will take place. This value counts up and when it reaches the value in Parameter 253 (Hours between Purge) then the Purge process will take place. This value only counts up when all the curtains are fully closed and is reset to 0 as soon as a curtain opens. This parameter counts by 0.1 every 6 minutes. The value displayed is in hours.

ⓓ99 Version

Parameter 99 displays the controller firmware version information.

Indicator Guide:

When viewing the average room temperature, the following indicators will show the status of curtains and on/off devices.

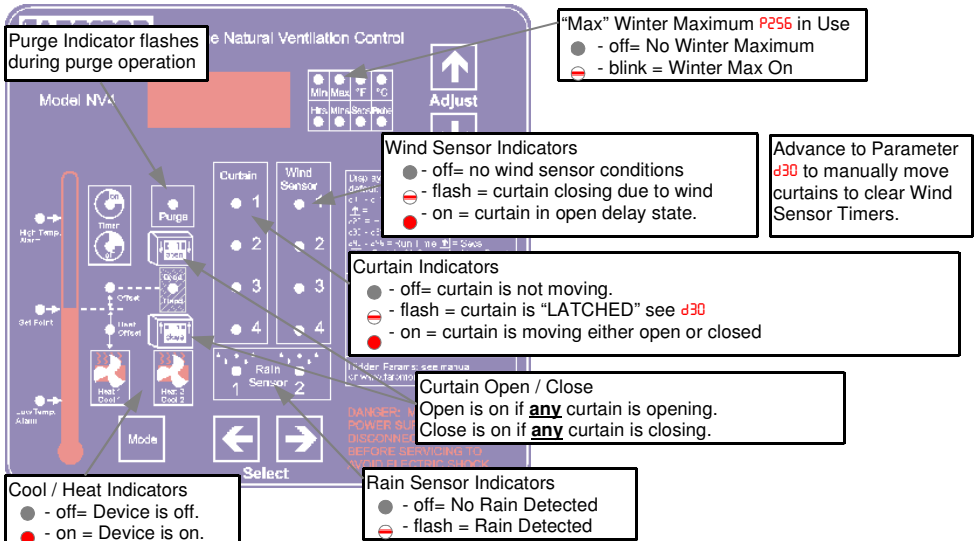

The screenshot shows a control interface with several indicators and their meanings:

- Purge Indicator:** Purge Indicator flashes during purge operation.
- Max Winter Maximum:** "Max" Winter Maximum P256 in Use
 - - off= No Winter Maximum
 - (with red border) - blink = Winter Max On
- Wind Sensor Indicators:**
 - - off= no wind sensor conditions
 - (with red border) - flash = curtain closing due to wind
 - (with red border) - on = curtain in open delay state.
- Advance to Parameter:** Advance to Parameter ⓓ30 to manually move curtains to clear Wind Sensor Timers.
- Curtain Indicators:**
 - - off= curtain is not moving.
 - (with red border) - flash = curtain is "LATCHED" see ⓓ30
 - (with red border) - on = curtain is moving either open or closed
- Curtain Open / Close:**
 - Open is on if **any** curtain is opening.
 - Close is on if **any** curtain is closing.
- Cool / Heat Indicators:**
 - - off= Device is off.
 - (with red border) - on = Device is on.
- Rain Sensor Indicators:**
 - - off= No Rain Detected
 - (with red border) - flash = Rain Detected

Standard Settings:

To view or modify Standard Settings,

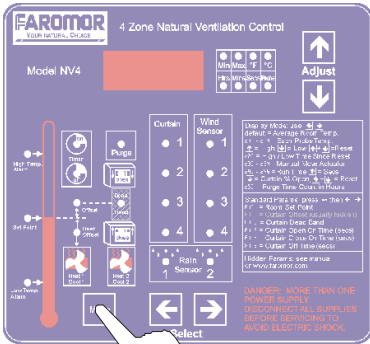

Press the **Mode** Button. If the display flashes **P 10 1** then you are in the Standard Settings Mode. You may need to press the **Mode**

Button a second time to get **P 10 1** to appear on the display.

The arrow will increase Parameter values. The arrow will decrease Parameter values.

The control may show **SECU** when attempting to change a value. See Parameter 261 to turn off the security setting.

NOTE: Control will automatically return to the default display mode 2 minutes after the last button press.

Use the select arrows and to choose various parameters.

P 10 1 Set Point

This parameter is the reference temperature. Most other temperature settings are set up relative to this reference temperature. This means that a setting such as the Output 1 Offset (turn-on) **P 15 1** may be set at +3.0° above the Set Point and a heater may be set up to turn on at -1.0° below the Set Point. Then when the Set Point is raised or lowered, the point at which Output 1 turns on and where the heater turns on will follow the change to the Set Point. The temperatures at which curtains will open and close will also change as the Set Point is changed.

*If security settings are set, it may not be possible to adjust anything other than parameter 101. (See Parameter **P25 1**)*

P 1 1 1 Curtain 1 Offset (hidden in simple mode)

In certain cases, it may be necessary for one curtain actuator to work from a slightly different reference temperature than the Set Point. This Parameter allows the user to specify a temperature offset. If the offset is set at 3.0°, then the centre of the deadband will be found at the Set Point + 3.0° and the curtain won't begin opening till the room is warmer by 3.0°. If it is set at -3.0° then the curtain will begin opening at a temperature 3.0° cooler than if this parameter was left at 0. When in simple mode (Parameter 203) this Parameter is hidden and a value of 0 is used for all Curtain Offsets.

P 112 Curtain 1 Deadband

This parameter defines the dead band for Zone 1. This is the temperature above and below the set point where the curtain will remain where it is. The dead band is centred on the set point. A dead band of 3.6° will not move the curtain unless the temperature climbs 1.8° above the Set Point or drops 1.8° below the Set Point.

P 113 Curtain 1 Open On Time

When the temperature is high enough and the curtains are to open, the actuator will open for the amount of time specified in this setting. Then the curtain will stop and remain in place for the “Off Time” below. There are 3 settings in the hidden settings that will automatically adjust the timers for a longer on-time if the room temperature is very far from the target temperature.

P 114 Curtain 1 Close On Time

When the room temperature is cool enough, the curtains will begin to close. The curtain will run for the amount of time specified in this setting then it will stop and remain in place for the “off” time (see next parameter).

P 115 Curtain 1 Off Time

After the curtain moves open or closed for the time specified, the curtain will stop for the time specified here. This allows time for the room temperature to adjust.

When Operation Level (Parameter 203) is set to 2 or 3, Offsets, Deadbands, On and Off times can be specified for each individual curtain. When Operation Level is set to 1, all the curtains use the values specified in Parameters 112 to 115.

Description	Curtain 1	Curtain 2	Curtain 3	Curtain 4
Offset from Set Point	P 111	P 121	P 131	P 141
Deadband	P 112	P 122	P 132	P 142
Open On Time	P 113	P 123	P 133	P 143
Close On Time	P 114	P 124	P 134	P 144
Off Time	P 115	P 125	P 135	P 145

P 151 Output 1 Turn-On (Only Appears if Output 1 is Active)

This value specifies the temperature at which Output 1 will turn on. (This setting is relative to the Set Point). See Hidden Parameter 231 to specify the Output 1 type. If Output 1 is configured for heat, when the temperature drops below Parameter 101 (Set Point) + this Parameter 151, the heater will turn on. The temperature must rise by the value in Parameter 235 before the heater will shut off again. If set as a cooling stage, Output 1 will turn on when the temperature rises above Parameter 101 (Set Point) + this Parameter 151. The temperature must drop by the value in Parameter 237 before the cooling device will turn off. The next 2 parameters can be used to cycle time a cooling device like a sprinkler.

P 152 Output 1 On Time (Appears if Output 1 is Active with Timer)

This Parameter is hidden unless Output 1 is configured to use the on/off cycle timer in Parameter 231. If Output 1 is configured to use the cycle timer then this Parameter specifies the on time in minutes. The time can be set in 0.1 minute increments (6 seconds). When the temperature is such that Output 1 is on, then the output will cycle on and off according to Parameters 152 and 153.

P 153 Output 1 Off Time (Appears if Output 1 is Active with Timer)

This Parameter is hidden unless Output 1 is configured to use the on/off cycle timer in Parameter 231. If Output 1 is configured to use the cycle timer then this Parameter specifies the off time in minutes. The time can be set in 0.1 minute increments (6 seconds).

P 161 P 162 P 163 Output 2 (Appears if Output 2 is Active)

These Parameters are much the same as Parameters 151 to 153 except these Parameters specify the operation Output 2. Output 2 is configured with hidden Parameter 233.

P 171 High Temp. Alarm

The high temperature alarm will activate if any of the probes exceeds the temperature specified here. Again, this temperature is relative to the set point so a value of 15°F would activate the alarm if the set point was 70°F and the room temperature reached 85°F.

P 172 Low Temp. Alarm

The low temperature alarm will activate if any of the probes drops below the temperature specified here. This parameter is relative to the Set Point and will usually be in the range of -3.0°F to -6.0°F. It is not usually necessary to change this setting during different seasons. This alarm will activate if the room becomes too cold.

Hidden Settings:

To view or modify Hidden Settings,

Press and hold the **Mode** Button until the display flashes **P20 !** (about 7 seconds) then you are in the Hidden Settings Mode.

The **▲** arrow will increase Parameter values.
The **▼** arrow will decrease Parameter values.

NOTE: Control will automatically return to the default display mode 2 minutes after the last button press.

Use the select arrows **◀** and **▶** to choose various parameters.

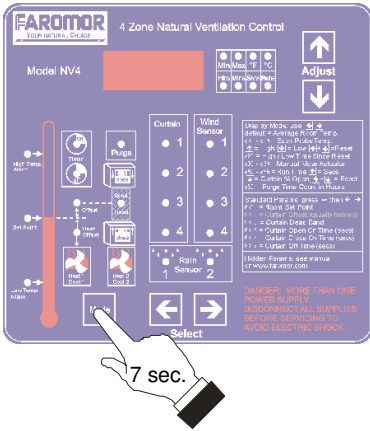

P20 ! Ventilation On / Off

Whenever there are animals in the room, this setting must be set to “On”. When the room is empty, this setting may be set to “Off” so that the curtains will no longer operate. If Output 1 or 2 is configured as a heater, it will continue to run to keep the room warm. It may be necessary to reduce the set point, as well as turning off the ventilation. This way the heater will only run when the room is in risk of freezing.

P202 °F / °C Selection

This parameter allows selection of temperature units between °F and °C.

P203 Operation Level

In typical natural ventilation barns, each of the curtains respond to temperature in the same manner using the same Set Point, Deadband, On Times and Off Time. If this is the case, Operation Level should be set to 1. This will cause Parameters 111 and 121 through 145 in the Standard Settings to become hidden and the control will use the Parameters for Curtain 1 for all of the curtains. In some situations, it may be necessary to set up some curtains to operate at different temperatures or with different deadband values or on and off times. If this is the case, set Operation Level to 2 and then adjust all the individual settings for Curtains 1 through 4 in the Standard Settings. Setting Operation Level to 3 will enable Parameters 241, 242 and 243, allowing for proportional timer adjustments based on the difference between actual and target temperatures.

P204 Alarms On/Off

In some installations, the control must send a signal when the temperature gets too hot or too cold. If alarms are required, turn Parameter 204 on. If high and low temperature alarms are not needed, this Parameter can be turned off.

P211 P212 P213 P214 Curtain 1,2,3,4 Probes to Use

This control supports up to 4 indoor probes. This parameter allows selection of the probes to be averaged and used by Curtain zones 1, 2,3 or 4. Any combination of the 4 probes can be selected. Setting this parameter to 'off' will turn off the curtain and it will not move automatically.

P221 Wind Sensor Close Time

This parameter defines how long the curtains will run closed after wind is detected by the wind sensor. This is usually set to several seconds. The timer gets reset every time wind is detected by the sensor. When this Parameter is set to 0, the wind sensing function is disabled. If the control is not equipped with wind sensors then this parameter should be set to 0.

P222 Wind Sensor Open Delay Time

If the curtain closes due to wind, the rise in temperature would normally cause the curtain to open again right away. To prevent this, an open delay timer prevents the curtains from opening for up to 254 minutes (4 hours). Normally, this value should be set to between 30 and 60 minutes. This timer is reset each time the wind sensors detect wind.

P223 Wind Sensor High Temperature Over-ride

This parameter sets a temperature at which point the wind sensor is ignored. On hot days, the curtain should remain open even if it is very windy. If the average room temperature is at or above this Parameter, the wind sensors will be ignored and the curtain will open normally even if the wind sensor is detecting wind.

P225 P226 Rain Sensor 1, Rain Sensor 2 Curtains

Select the curtains to be closed when rain is detected by Rain Sensor 1 (P225) and Rain Sensor 2 (P226)

P227 Rain Sensor Open Time (seconds)

When the rain sensor causes a curtain to close, a timer will be used based on P245 - P248 to make sure the curtain closes completely. Then the curtain will open for the amount of time specified here to ensure that the curtain is at least partially open. While rain is being detected, the curtain will not open any further although cool temperatures or wind sensors may cause the curtain to close.

P228 Rain Sensor Off Time (minutes)

Once the rain stops, this timer begins. The curtain remains in rain sensor mode during this time and if rain starts again, the timer is re-set. Once this timer expires, the curtain will return to normal operation.

P229 Rain Sensor High Temperature Override

When rain is detected and the curtains are closed, it may get too hot inside the building. When the average room temperature goes above the value specified here, the curtains will return to normal operation and will likely open due to the high temperature. This, unfortunately may allow rain to enter the building but it will prevent severe heat stress on the animals.

P231 Output 1 Configure as Off / Heat / Cool / Timer

This setting allows Output 1 to be:

1. **OFF** - The stage will not turn on when this setting is selected. Parameters 151, 152 and 153 will be hidden.
2. **HEAT** - This stage is now set to come on as a heating stage. Parameter 151 is used to set the turn-on temperature.
3. **COOL** - This stage is now set to come on as a cooling stage. Parameter 151 is used to set the turn-on temperature.
4. **HE-T** - This stage is now set as a heating stage with a timer. Parameters 152 and 153 are used to set the on and off times.
5. **CO-T** - This stage is now set as a cooling stage with a timer. Most often this would be used with a misting system. Parameters 152 and 153 will be visible and are used to set the on and off times.

P232 Output 1 Probes to Average

It is possible for the on/off stages to use individual probes or to use an average. This is useful if 2 heaters are used on opposite ends of a larger room. Use this Parameter to select which probes are used for Output 1.

P233, 234 Output 2 Configure and Probes

These parameters have the same options as Parameters 231 and 232 but are for setting up Output 2 instead of Output 1. Turn on and cycle timer settings are Parameters 161, 162 and 163. Parameter 234 selects the probes to use for Output 2.

P235 Output 1 & 2 Heat Differential

When a heater turns on, it is important that the heater does not immediately shut off again when the temperature rises a slight amount. This Parameter specifies just how much the temperature must rise before the heater shuts off. For

example. If a heater turns on at 73.2° and this parameter is set to 1.0°, the heater will continue to run until the temperature rises above 74.2°. This value is usually set between 0.5° and 2.7° (0.3 and 1.5°C).

P236 Curtain Differential

There may be unusual conditions where the temperature in the room changes rather quickly. Since the curtains operate on a timing cycle that may take over a minute to complete, the curtain differential is needed to stop a curtain from moving open or closed when there is a rather sudden change in temperature. It works much the same as the heater differential. For example, if the Curtain Differential is set to 0.8°F and if the curtain starts to open at 77°F and the temperature in the room suddenly drops by 1.0°F while the actuator is running, the curtain will stop due to the fact the temperature dropped by a value greater than the curtain differential.

P237 Output 1 & 2 Cool Differential

When a fan or other cooling device turns on, it is important that the device does not immediately shut off again when the temperature drops a slight amount. This Parameter specifies just how much the temperature must drop before the device shuts off. For example. If a fan turns on at 79° and this parameter is set to 1.0°, the fan will continue to run until the temperature drops below 78°. This value is usually set to between 0.3° and 1.8°F (0.2 and 1.0°C)

Automatic Curtain Timer Adjustment

The next 3 settings allow an automatic increase in the on-time when the room temperature is quite distant from the set point. These settings are hidden unless Parameter 203 is set to Operation Level 3. There are times when the outdoor temperature can change quite suddenly and a slow moving curtain can take a long time to compensate for this sudden change. Then next 3 parameters can greatly speed up the response of a curtain to a sudden and significant change in temperature. These settings will affect the on and off times of all curtains in the same manner.

P241 Curtain Timer Compensation No Adjust Band

The value entered here indicates the temperature range above and below the Dead Band where the Curtain Open On-Time (Parameter **P113**) and Curtain Close On-Time (Parameter **P114**), follow the On-Times set in Parameters **P113** and **P114**. This parameter is disabled if parameters **P242** and **P243** are set to 0 or **P203** is set to Operation Level 1 or 2..

P242 Maximum On-Time

The value entered here indicates the Maximum On-Time that the curtain will use. If the Maximum On-Time entered here is greater than the [Open On-Time

(Parameter P113) + Off-Time (Parameter P115)], or greater than the [Close On-Time (Parameter P114) + Off-Time (Parameter P115)], the controller will give the Off-Time a value of 5 seconds. Otherwise, the on time is increased and the off time is decreased as needed.

P243 Timer Compensate Proportional Band

The value entered here indicates the bandwidth over which the curtain goes from (Minimum On-Time, Maximum Off-Time) to (Maximum On-Time, Minimum Off Time).

For example:	Parameter P101 (Set Point)	70.0°F
	Parameter P112 (Curtain Dead Band)	5.0°F
	Parameter P113 (Curtain Open On-Time)	60 sec.
	Parameter P115 (Curtain Off-Time)	60 sec.
	Parameter P241 (Cur. Timer Comp. No Adjust Band)	1.0°F
	Parameter P242 (Max. On-Time)	90 sec.
	Parameter P243 (Timer Comp. Prop. Band)	2.0°F

Using example settings: When the Temperature in the room increases and reaches 72.5°F (Parameter P101 + 1/2 of Parameter P112), the curtain starts to cycle Open for 60 sec. (Parameter P113) Off for 60 sec. (Parameter P115). The curtain will continue to cycle Open 60 sec., Off 60 sec. for another 1.0°F increase in temperature (73.5°F), since this is the value set in Parameter P241 (No adjust band setting). If the temperature continues to rise in the room in the range of 73.6°F to 75.5°F, (P243 is this 2.0°F bandwidth), the controller will gradually increase the Open On-Time and decrease the Off Time until the Max. Open On-Time is 90 sec. (Parameter P242). The Off time would be reduced to 30 seconds.

P245 P246 P247 P248 Total Time to Run Curtain from Open to Closed

This Parameter is very important for the purge function but it also is used to properly estimate Curtain Run Times (Parameters P443 to P446). A stop watch must be used to time how long it takes to run the curtain from the fully open position to the fully closed position. Enter the number of minutes that it takes for the curtain to fully close. Do this for each of the curtains since curtains of different heights may be used. If all curtains are the same, enter the same time in each of the 4 settings. P245 is for Curtain 1, P246 for Curtain 2, etc. This can be specified to 1 decimal place where each 0.1 count is 6 seconds so a time of 8 minutes, 30 seconds would be entered as 8.5 minutes. The control will keep track of the amount of time the curtains run open and closed and will use the times to determine when the curtain has reached the fully open or fully closed position. When all of the curtains have reached the fully closed position, the Purge Hour Counter begins to count.

Purging

In the winter, a naturally ventilated barn can experience very poor ventilation conditions due to the fact the cold temperatures cause all the curtains to stay fully closed all the time. It is possible to use the next 5 Parameters to force 1 or more of the curtains to open for a set time every few hours, allowing some fresh air to enter the building even on very cold days.

P251 Curtain(s) to use for Purge Function

Use this Parameter to select which curtains will open up for the purge process. Normally, curtains on the leeward side of the building should be specified to ensure that cold wind does not usually enter the building. Note that a control equipped with wind sensors will immediately exit the purge function if a wind sensor is activated.

P253 Purge Hour Count

As described in Parameter P245 to P248 the control will determine when all curtains are fully closed. The Purge Hour Counter then begins to count, incrementing by 0.1 every 6 minutes. If the Purge Hour Count reaches the value of this Parameter, a Purge Event is initiated. Any time a curtain opens, the Purge Hour Counter is reset to 0.

P254 Purge Open Time

Once a purge process is initiated, all of the Purge Curtains (Parameter P251) will run open without any pause for the number of minutes specified in this Parameter. Once the curtains have run open, there will be a delay as specified by the next Parameter (P255)

P255 Purge Wait Time

Once the curtains have been run open for the time specified in P254, the curtains will stop and a wait timer starts. The curtains will stop and stay in place for the number of minutes specified by this Parameter. Once the wait timer expires, the curtain will return to automatic operation. It is important to note that the Purge operation will likely lead to a temperature drop and the curtains will be open slightly. Once the Purge process is complete, the control will normally begin closing the curtains due to the cooler temperature and it will use the Close On Time (P114) and Off Time (P115) which means it may take considerably longer for the curtains to close fully than it did for the Purge Function to open them. This needs to be considered when setting the timers for the Purge Function.

Winter Maximum Open Settings

In the winter, it is useful to limit how far open the curtains will go. These 5 settings can be used to set open limits for the curtains during cold weather. Since the curtain positioning uses time to track curtain positions, the position of the curtains is unknown during power up. When the winter maximum curtain open settings are functioning, the control will fully close each curtain in turn for a sufficiently long time that the control can be sure that the curtain has fully closed. The control will do this on one curtain at a time to ensure that the room temperature does not rise too high. If, at any time, the room average temperature or the Set Point (P 10 I) exceeds Winter Maximum High Temperature (P260) then the Winter Maximum Function is canceled. For this function to work, Parameters 245 – 248 must be properly set for the curtain Run Times. When the Winter Maximum is active, the MAX Indicator will flash on for about 1/10th of a second every 2 seconds. Whenever a curtain has stopped due to being open to the Winter Maximum Position, the Curtain Indicator will also flash for about 1/10th of a second every 2 seconds to indicate to the operator that the Winter Maximum is in effect.

P256 Curtain 1 Maximum % Open

Use this Parameter to set how far open curtain 1 may go as long as the room temperature remains below the value specified in Parameter 260 (P 10 I). This setting is in % of full open and uses the Total Run Time Open to track how far open the curtain is. The curtain can still be opened beyond this position when moved manually. When operating in automatic, the curtain will not open beyond the distance specified here. The Winter Maximum function is disabled for this curtain when this value is set to 100%.

P257 P258 P259 Curtain 2, 3, 4 Maximum % Open

Use these parameters to specify how far open Curtains 2, 3 and 4 can open in the Winter Maximum condition.

P260 Winter Maximum High Temperature Override

Some weather conditions may lead to very high temperatures in the barn when the curtain distance open is limited. If the room temperature (or the Set Point (P 10 I)) exceed the value in this parameter, the Winter Maximum function is disabled and the curtains will open beyond the limits specified by (P256 to 259).

P26 I Security On/Off

When set to On, this parameter prevents the operator from adjusting Standard Settings other than 101.

Standard Settings Chart:

Standard Settings – Press Mode Button Once to Access.

Setting	Units	Factory Default	Range	Record Your Settings
i01 Set Point	°F °C	50.0 10.0	-40 to 99 -40 to 37.2	
i11 Offset Temp. Zone 1	°F °C	0.0 0.0	-36 to 36 -20 to 20	
i12 Dead Band Zone 1	°F °C	3.6 2.0	0 to 36 0 to 20	
i13 Curtain Open On-Time	Seconds	10	0 to 254	
i14 Curtain Close On-Time	Seconds	15	0 to 254	
i15 Curtain Off Time	Seconds	120	0 to 254	
i21 Offset Temp. Zone 2	°F °C	0.0 0.0	-36 to 36 -20 to 20	
i22 Dead Band Zone 2	°F °C	3.6 2.0	0 to 36 0 to 20	
i23 Curtain 2 Open On-Time	Seconds	10	0 to 254	
i24 Curtain 2 Close On-Time	Seconds	15	0 to 254	
i25 Curtain 2 Off Time	Seconds	120	0 to 254	
i31 Offset Temp. Zone 3	°F °C	0.0 0.0	-36 to 36 -20 to 20	
i32 Dead Band Zone 3	°F °C	3.6 2.0	0 to 36 0 to 20	
i33 Curtain 3 Open On-Time	Seconds	10	0 to 254	
i34 Curtain 3 Close On-Time	Seconds	15	0 to 254	
i35 Curtain 3 Off Time	Seconds	120	0 to 254	
i41 Offset Temp. Zone 4	°F °C	0.0 0.0	-36 to 36 -20 to 20	
i42 Dead Band Zone 4	°F °C	3.6 2.0	0 to 36 0 to 20	
i43 Curtain 4 Open On-Time	Seconds	10	0 to 254	
i44 Curtain 4 Close On-Time	Seconds	15	0 to 254	
i45 Curtain 4 Off Time	Seconds	120	0 to 254	
i51 Aux Output 1 Offset	°F °C	0.0	-36 to 36 -20 to 20	
i52 Aux 1 Cycle Timer On-Time	Minutes	0.0	0.0 to 25.4	
i53 Aux 1 Cycle Timer Off-Time	Minutes	0.0	0.0 to 25.4	
i61 Aux Output 2 Offset	°F °C	0.0	-36 to 36 -20 to 20	
i62 Aux 2 Cycle Timer On-Time	Minutes	0.0	0.0 to 25.4	
i63 Aux 2 Cycle Timer Off-Time	Minutes	0.0	0.0 to 25.4	
i71 High Temp. Alarm	°F °C	18.0 10.0	-36 to 0 -20 to 0	
i72 Low Temp. Alarm	°F °C	-18.0, -10.0	-36 to 0 -20 to 0	



Gray Params may be hidden due to Value of Parameter 203.



Magenta Parameters may be hidden due to Value of Parameter 231 and 233.

Hidden Settings Chart Page 1 of 2:

Hidden Settings – Hold Mode Button for 6 Seconds to Access.

Setting	Units	Factory Default	Range	Record Your Settings
201 Curtains On/Off		on	On / Off	
202 Temp. Units		°F	°F / °C	
203 Operation Level		1	1 .. 3	
204 Enable Alarm Output		Off	On / Off	
211 Curtain 1 Probes to use.		1	off, 1 to 4	
212 Curtain 2 Probes to use.		2	off, 1 to 4	
213 Curtain 3 Probes to use.		3	off, 1 to 4	
214 Curtain 4 Probes to use.		4	off, 1 to 4	
221 Wind Sense Close Timer	Seconds	10	0 to 254	
222 Wind Open Delay Timer	Minutes	60	0 to 254	
223 Wind High Temp Inhibit	°F °C	77.0 25.0	-40 to 99 -40 to 37.2	
225 Rain Sensor 1 Curtains to Close		off	off, 1 to 4	
226 Rain Sensor 2 Curtains to Close		off	off, 1 to 4	
227 Rain Sensor Open Time	Seconds	20	0 to 254	
228 Rain Sensor Off Time	Minutes	10	0 to 254	
229 Rain Sensor High Temp Inhibit	°F °C	86.0 30.0	-40 to 99 -40 to 37.2	
231 Aux 1 Heat / Cool / Timer		Off	Off, Heat / Cool / Timer	
232 Aux 1 Probes to use.		1234	off, 1 to 4	
233 Aux 2 Heat / Cool / Timer		Off	Off, Heat / Cool / Timer	
234 Aux 2 Probes to use.		1234	off, 1 to 4	

Hidden Settings Chart Page 2 of 2:

Hidden Settings – Continued

Setting	Units	Factory Default	Range	Record Your Settings
235 Heater	°F	1.0	0 to 36	
Differential	°C	0.5	0 to 20	
236 Curtain	°F	0.5	0 to 36	
Differential	°C	0.3	0 to 20	
237 Cool	°F	1.0	0 to 36	
Differential	°C	0.5	0 to 20	
241 Curtain No	°F	1.0	0 to 36	
Adjust Band	°C	0.5	0 to 20	
242 Curtain Max On-Time	Seconds	0	0 to 254	
243 Curtain Adj. Prop. Band	°F	3.6	0 to 36	
	°C	2.0	0 to 20	
245 Curtain 1 Total Close Time	Minutes	8.0	0.0 to 25.4	
246 Curtain 2 Total Close Time	Minutes	8.0	0.0 to 25.4	
247 Curtain 3 Total Close Time	Minutes	8.0	0.0 to 25.4	
248 Curtain 4 Total Close Time	Minutes	8.0	0.0 to 25.4	
251 Purge Seq. Curtains to Use		Off	Off, 1-4	
253 Purge When Closed Time =	Hours	0.0	0.0 to 25.4	
254 Purge Open Time	Minutes	0.5	0.0 to 25.4	
255 Purge Wait Time	Minutes	2.0	0.0 to 25.4	
256 Curtain 1 Winter Max %	%	100	0 to 100	
257 Curtain 2 Winter Max %	%	100	0 to 100	
258 Curtain 3 Winter Max %	%	100	0 to 100	
259 Curtain 4 Winter Max %	%	100	0 to 100	
260 Winter Max High Temp Disable	°F	86.0	-40 to 99	
	°C	30.0	-40 to 37.2	
261 Security Status		Off	On/Off	

Control Mounting Instructions

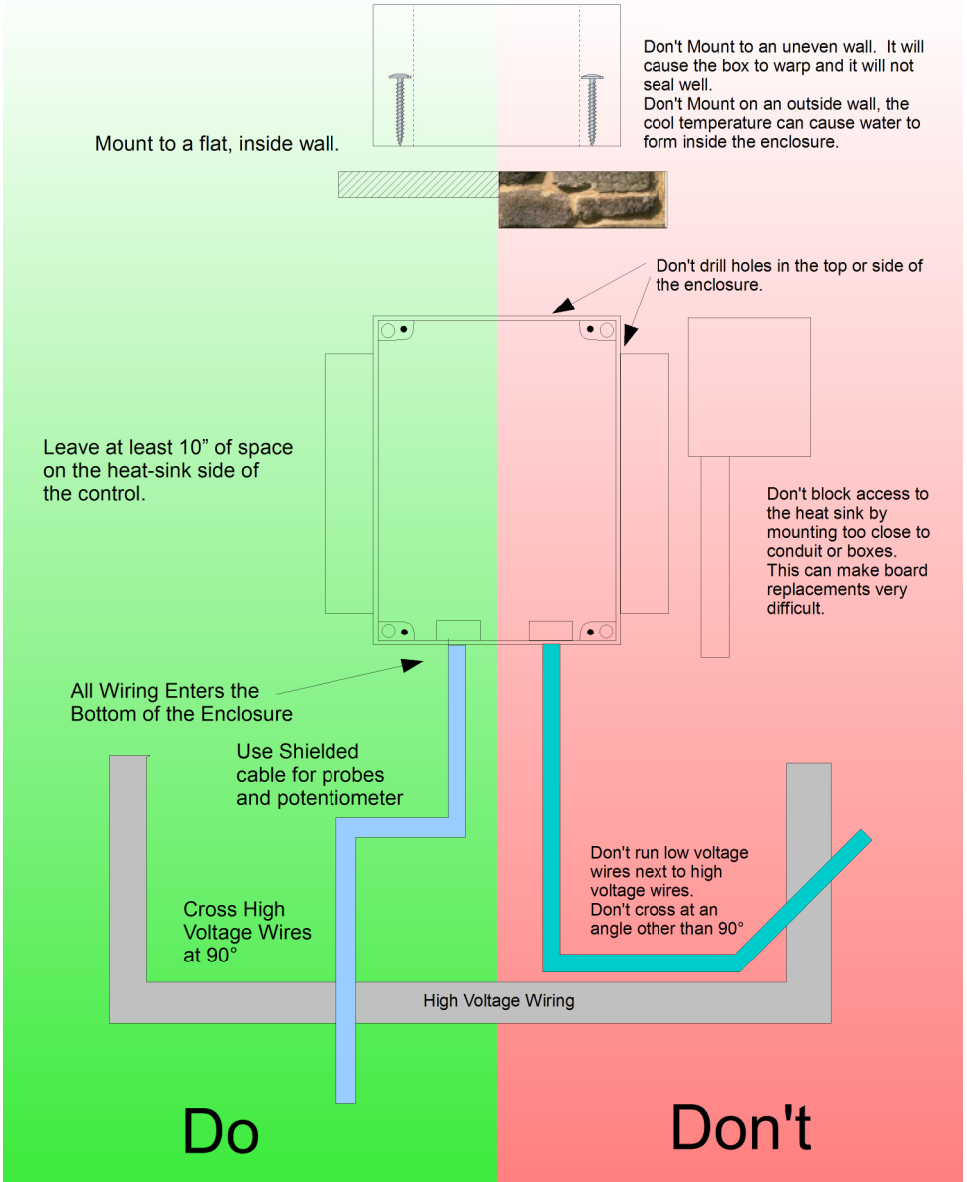

Be sure to connect a backup thermostat to drop the curtains in the event of a control failure.

NV4 Wiring Diagram

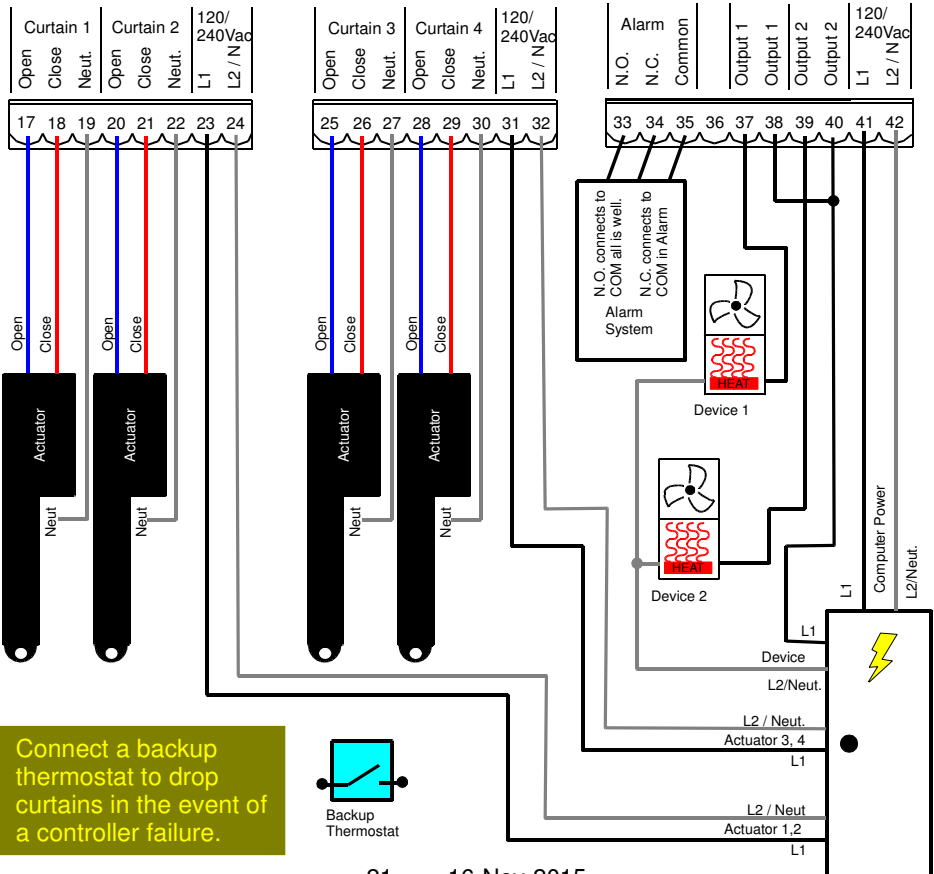
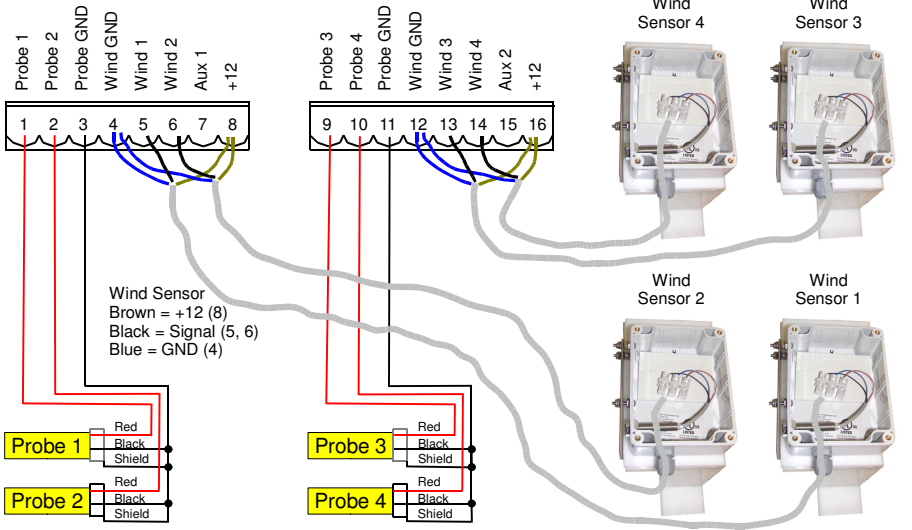

Connect a backup thermostat to drop curtains in the event of a controller failure.

Limited Warranty

Faromor hereby warrants that should this unit prove defective, Faromor will repair the unit free of charge but subject to the following conditions and a time period of 1 year at 100% coverage of parts and labour to repair or replace the unit as determined by Faromor. Faromor assumes no responsibility for losses resulting directly or indirectly from the use of this control unit beyond the replacement or repair of the control unit.

1. The unit must have been installed in accordance with the installation instructions contained in this manual, such that the contents of the control are protected from moisture and dust using liquid tight connections on all wiring into the control housing. Any holes cut into top or side of control enclosure void warranty of controller.
2. No modification of the control has been done by anyone other than qualified Faromor personnel.
3. The control unit must not have been subject to abuse, misuse or accident or operated other than as specified in this manual. Any decision on this condition by Faromor will be final.
4. Warranty will only be provided to the original purchaser of this product and proof of purchase must be provided at the time of a warranty request. Warranty period begins at date of manufacture as found on the control unit unless date of sale and serial numbers are clearly indicated on proof of purchase documents.
5. This warranty is only applicable to control unit NV4
6. All shipping charges are the responsibility of the purchaser.
7. For best warranty service, return a defective control unit to your local dealer along with proof of purchase of the unit.

DISCLAIMER: EXCEPT AS PROHIBITED BY APPLICABLE LAW, AND EXCEPT AS SPECIFIED ABOVE, FAROMOR MAKES NO WARRANTIES OR REPRESENTATIONS, EXPRESS OR IMPLIED, ORAL OR WRITTEN, REGARDING THE CONTROL UNIT OR DOCUMENTATION AND HEREBY EXPRESSLY DISCLAIMS ALL OTHER EXPRESS AND IMPLIED WARRANTIES, INCLUDING THE IMPLIED WARRANTIES OF MERCHANTABILITY AND FITNESS FOR A PARTICULAR PURPOSE. FAROMOR DOES NOT WARRANT THE UNIT WILL MEET YOUR REQUIREMENTS OR THAT ITS OPERATION WILL BE UNINTERRUPTED OR ERROR FREE.