

TYPICAL VERTICAL DAMPER

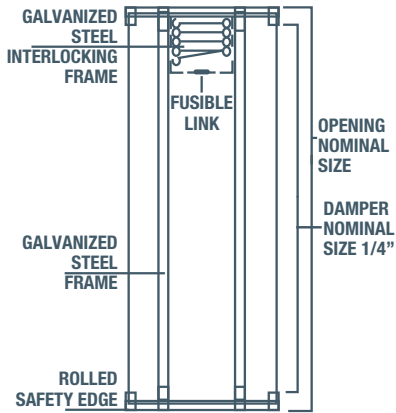

TYPE A - FIRE DAMPERS VERTICAL & HORIZONTAL

SUGGESTED INSTALLATION

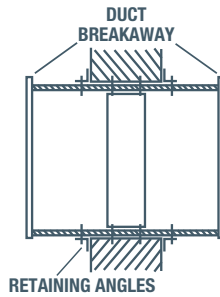

TYPICAL HORIZONTAL DAMPER

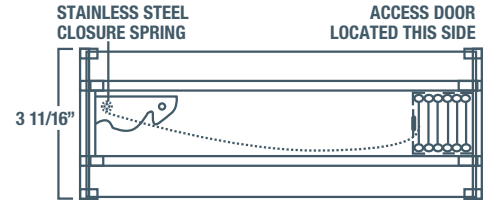

FEATURES

- Narrow 2 3/16" or 1 1/2" frame
- Electro thermal links - 165°F standard
- Other fusible links 135°F, 212°F, 286°F
- Adjustable blade stack for combination fire/balancing damper
- Solenoid release

- Micro-switches for fan shut off and/or status control
- Stainless steel construction
- 1 1/2 hour rating standard - 3 hour optional vertical only
- Maximum size: 36" x 36"; Minimum size: 6" x 6"



Type A & Type B Fire Dampers are non-standard dampers and are not-returnable and cannot be cancelled.

SPECIAL NOTE



When the damper or damper assembly exceeds either 48" in width or 60" in height, the retaining angles should not be less than 1 1/2" x 1 1/2" x 1/8" thick and should be attached to the sleeve using 20 1/4" x 3/4" round head stove bolts at 8" on C. 1" long welds or No. 14 x 3/4" sheet metal screws at the same spacing.

TYPE B - FIRE DAMPERS VERTICAL & HORIZONTAL

FEATURES

- Narrow 2 3/16" or 1 1/2" frame
- Electro thermal links - 165°F standard
- Other fusible links 135°F, 212°F, 286°F
- Adjustable blade stack for combination fire/balancing damper
- Solenoid release
- Micro-switches for fan shut off and/or status control
- Stainless steel construction
- 1 1/2 hour rating standard - 3 hour optional vertical only
- Maximum size: 36" x 36"; Minimum size: 6" x 4"

SPECIAL NOTE



When the damper or damper assembly exceeds either 48" in width or 60" in height, the retaining angles should not be less than 1 1/2" x 1 1/2" x 1/8" thick and should be attached to the sleeve using 20 1/4" x 3/4" round head stove bolts at 8" on C. 1" long welds or No. 14 x 3/4" sheet metal screws at the same spacing.

TYPICAL VERTICAL DAMPER

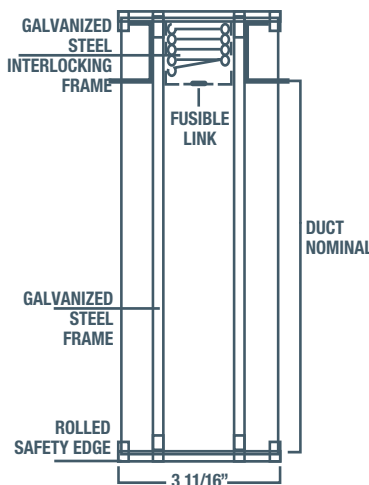

SUGGESTED INSTALLATION

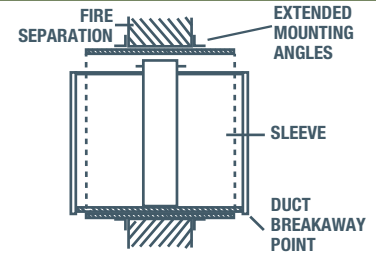

ALTERNATE INSTALLATION

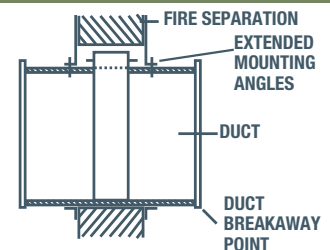

TYPICAL HORIZONTAL DAMPER

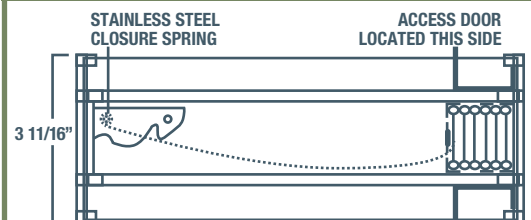

Type A & Type B Fire Dampers are non-standard dampers and are not-returnable and cannot be cancelled.